



P-09

€ E.379

- Cerniera tutt'altezza per applicazione su stipiti battuta da 40 mm. Altezza standard cerniera 2400 mm.
- Hinge profile. for frames with rebate depth 40 mm. Hinge standard height 2400 mm.
- Bandprofil für Falztiefe 40 mm. Band standard Höhe 2400 mm.

AN



L=2400 mm

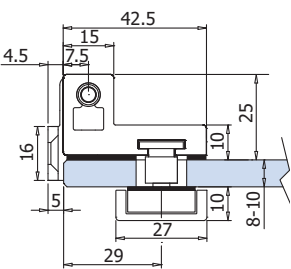
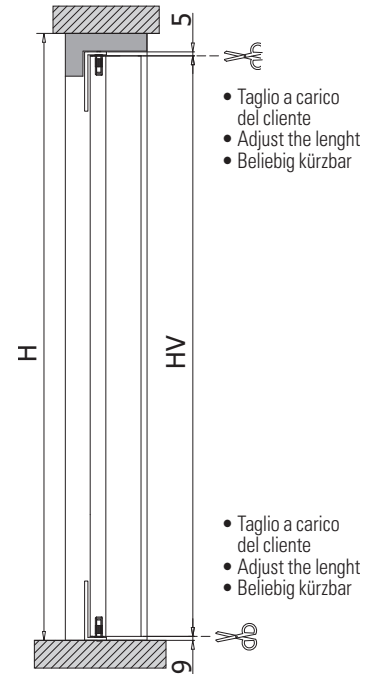

**LAVORAZIONE VETRO
GLASS PREPARATION
GLASBEARBEITUNG**

- I fori sul vetro possono essere posizionati a piacimento grazie alle bussole regolabili.
- The holes can be positioned at will thanks to the adjustable fixing points.
- Die Bohrungen können nach belieben durch die verstellbaren Befestigungspunkte positioniert werden.

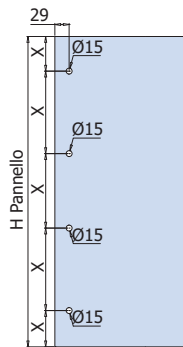
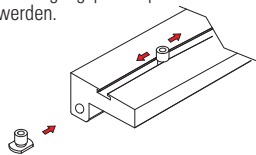

V-122-SD (incluso / included / enthalten)

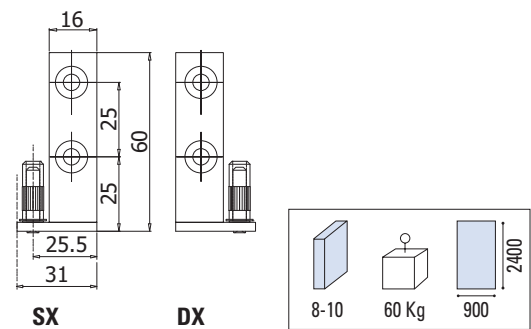

Cerniera applicabile ai seguenti stipiti / Hinge available for following frames / Band an folgende Zargen montierbar

P-030 / P-040

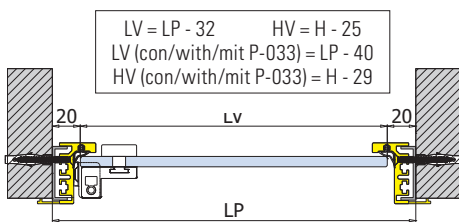
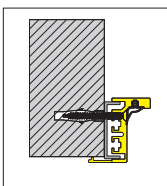

TP-250

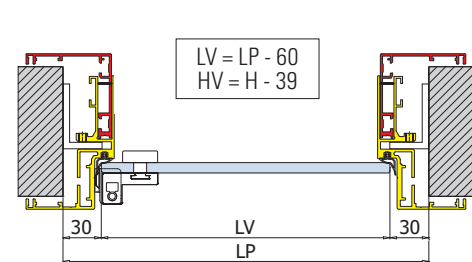
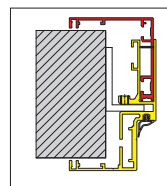

TP-100

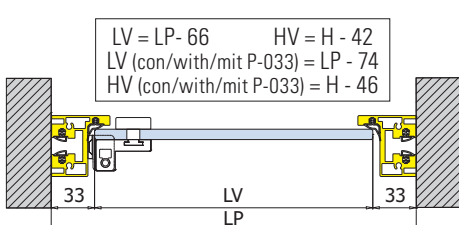
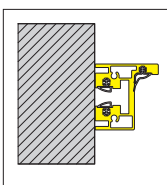

P-070

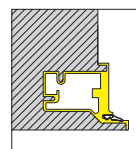

P-060

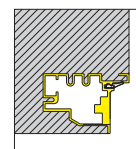

TP-201

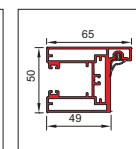

TP-300

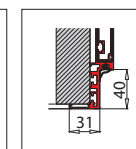

xme199c2 / xme199i

LP
Passaggio luce
Clear opening width
Lichte Durchgangsbreite

LV
Larghezza vetro
Glass width
Glasbreite

HV
Altezza vetro
Glass height
Glashöhe

H
Altezza passaggio luce
Clear opening height
Lichte durchgangshöhe